

DAEWOO

MICROWAVE OVEN

KOG-390A

**OPERATING
INSTRUCTIONS**

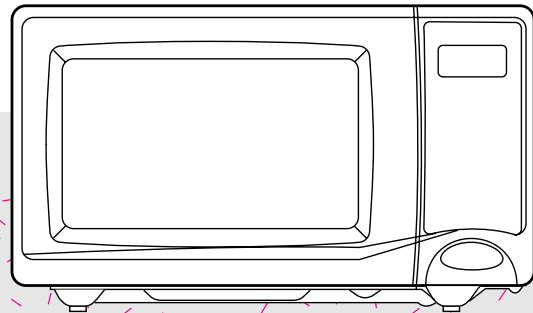

Before operating this oven, please read these instructions completely.

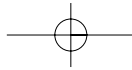

PRECAUTIONS TO AVOID POSSIBLE EXPOSURE TO EXCESSIVE MICROWAVE ENERGY

- (a) Do not attempt to operate this oven with the door open since open-door operation can result in harmful exposure to microwave energy. It is important not to defeat or tamper with the safety interlocks.
- (b) Do not place any object between the oven front face and the door or allow soil or cleaner residue to accumulate on sealing surfaces.
- (c) **WARNING** : If the door or door seals are damaged, the oven must not be operated until it has been repaired by a trained person : (1) door (bent), (2) hinges and latches(broken or loosened), (3) door seals and sealing surfaces.
- (d) **WARNING** : It is hazardous for anyone other than a trained person to carry out any service or repair operation which involves the removal of any cover which gives protection against exposure to microwave energy.
- (e) **WARNING** : Liquids or other foods must not be heated in sealed containers since they are liable to explode.
- (f) **WARNING** : Only allow children to use the oven without supervision when adequate instructions have been given so that the child is able to use the oven in a safe way and understands the hazards of improper use.

TABLE OF CONTENTS

PRECAUTIONS	1
EARTHING INSTRUCTIONS	2
INSTALLATION	2
SPECIFICATIONS	3
IMPORTANT	3
IMPORTANT SAFETY INSTRUCTIONS	4
FEATURES DIAGRAM	5
OPERATION PROCEDURE	7
CONTROLS	8
SETTING THE CLOCK	8
TIME DEFROSTING	8
WEIGHT DEFROSTING	9
COOKING IN ONE STAGE	10
COOKING IN TWO STAGES	10
GRILL COOKING	11
COMBI COOKING	11
KITCHEN TIMER MODE	12
SPEEDY COOK	13
ONE TOUCH COOKING	13
AUTO COOK	14
LESS, MORE	15
CHILD SAFETY LOCK	15
TO STOP THE OVEN WHILE THE OVEN IS OPERATING	15
COOKING UTENSILS	16
CARE AND CLEANING	16
BEFORE YOU CALL FOR SERVICE	17
QUESTIONS AND ANSWERS	17

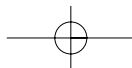

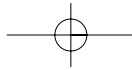

EARTHING INSTRUCTIONS

This appliance must be earthed. In the event of an electrical short circuit, earthing reduces the risk of electric shock by providing an escape wire for the electric current. This appliance is equipped with a cord having a earthing wire with an earthing plug. The plug must be plugged into an outlet that is properly installed and earthed.

WARNING: Improper use of the earthing plug can result in a risk of electric shock. Consult a qualified electrician or serviceman if the earthing instructions are not completely understood, or if doubt exists as to whether the appliance is properly earthed. If it is necessary to use an extension cord, use only a 3-wire extension cord that has a 3-blade earthing plug, and a 3-slot receptacle that will accept the plug on the appliance. The marked rating of the extension cord should be equal to or greater than the electrical rating of the appliance.

INSTALLATION

1 Steady, flat location

This oven should be set on a steady, flat surface. This oven is designed for counter top use only.

2 Leave space behind and side

All air vents should be kept a clearance. If all vents are covered during operation, the oven may overheat and, eventually, oven failure.

3 Away from radio and TV sets

Poor television reception and radio interference may result if the oven is located close to a TV, Radio antenna, feeder and so on.

Position the oven as far from them as possible.

4 Away from heating appliance and water taps

Keep the oven away from hot air, steam or splash when choosing a place to position it, or the insulation might be adversely affected and breakdowns occur.

5 Power supply

- Check your local power source. This oven requires a current of approximately 11 amperes, 230V 50Hz.
- Power supply cord is about 0.8 meters long.
- The voltage used must be the same as specified on this oven. Using a higher voltage may result in a fire or other accident causing oven damage. Using low voltage will cause slow cooking. We are not responsible for damage resulting from use of this oven with a voltage of ampere fuse other than those specified.
- If the supply cord is damaged, it must be replaced by the manufacturer or its service agent or a similarly qualified person in order to avoid a hazard.

6 Examine the oven after unpacking for any damage such as:

A misaligned door, Broken door, A dent in cavity. If any of the above are visible, DO NOT INSTALL, and notify dealer immediately.

7 Do not operate the oven if it is colder than room temperature.

(This may occur during delivery in cold weather.) Allow the oven to become room temperature before operating.

8 The minimum height of free space necessary above the top surface of the oven is 100mm.

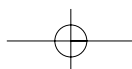

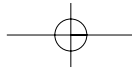

SPECIFICATIONS

POWER SUPPLY		230V~50Hz, SINGLE PHASE WITH EARTHING
POWER CONSUMPTION	MICROWAVE	1350 W
	GRILL	1050 W
	COMBINATION	2350 W
MICROWAVE ENERGY OUTPUT		900W
MICROWAVE FREQUENCY		2450MHz
OUTSIDE DIMENSIONS (WXHxD)		495X294X388mm
CAVITY DIMENSIONS (WXHxD)		320X244X338mm
NET WEIGHT		APPROX. 15.8Kg
TIMER		59 min. 90 sec.
POWER SELECTIONS		10 LEVELS
CAVITY VOLUME		0.9 Cu.Ft.

* Specifications are subject to change without notice.

IMPORTANT

The wires in this mains lead are coloured in accordance with the following code.

Green-and-yellow : Earth
 Blue : Neutral
 Brown : Live

As the colours of the wires in the mains lead of this appliance may not correspond with the coloured markings identifying the terminals in your plug, proceed as follows:

The wire which is coloured green-and-yellow must be connected to the terminal in the plug which is marked with the letter 'E' or by the earth symbol or green-and-yellow. The wire which is coloured blue must be connected to the terminal which is marked with the letter 'N' or coloured black.

The wire which is coloured brown must be connected to the terminal which is marked with the letter 'L' or coloured red.

WARNING: This appliance must be earthed.

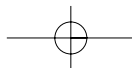

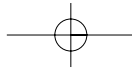

IMPORTANT SAFETY INSTRUCTIONS

**WARNING : To prevent fire, burns, electric shock and other warnings:
Listed below are, as with all appliances, certain rules to follow and safeguards to assure
top performance from this oven:**

1. Do not use the oven for any reason other than food preparation, such as for drying clothes, paper, or any other nonfood items or for sterilizing purposes.
2. Do not use the oven when empty, this could damage the oven.
3. Do not use the oven cavity for any type of storage, such as papers, cookbook, cookware, etc.
4. Do not operate the oven without the glass tray in place. Be sure it is properly sitting on the rotating base.
5. Make sure you remove caps or lids prior to cooking when you cook food sealed in bottles.
6. Do not put foreign material between the oven surface and door. It could result in excessive leakage of microwave energy.
7. Do not use recycled paper products for cooking. They may contain impurities which could cause sparks and/or fires when used during cooking.
8. Do not pop popcorn unless popped in a microwave approved popcorn popper or unless it's commercially packaged and recommended especially for microwave ovens.
Microwave popped corn produces a lower yield than conventional popping; there will be a number of unpopped kernels. Do not use oil unless specified by the manufacturer.
9. Do not cook any food surrounded by a membrane, such as egg yolks, potatoes, chicken livers, etc., without first piercing them several times with a fork.
10. Do not pop popcorn longer than the manufacturer's directions. (popping time is generally below 3 minutes).
Longer cooking does not yield more popped corn, it can cause scorchings and fire.
Also, the cooking tray can become too hot to handle or may break.
11. If smoke is observed, switch off or unplug the appliance and keep the door closed in order to stifle any flames.
12. When heating food in plastic or paper containers, check the oven frequently due to the possibility of ignition.
13. The contents of feeding bottles and baby food jars are to be stirred or shaken and the temperature is to be checked before consumption, in order to avoid burns.
14. Always test the temperature of food or drink which has been heated in a microwave oven before you give it to somebody, especially to children or elderly people. This is important because things which have been heated in a microwave oven carry on getting hotter even though the microwave oven cooking has stopped.
15. Eggs in their shell and whole hard-boiled eggs shall not be heated in microwave ovens since they may explode.
16. Keep the waveguide cover clean at all times. Wipe the oven interior with a soft damp cloth after each use. If you leave grease or fat anywhere in the cavity it may overheat, smoke or even catch fire when next using the oven.
17. Never heat oil or fat for deep frying as you cannot control the temperature and doing so may lead to overheating and fire.
18. Microwave heating of beverages can result in delayed eruptive boiling, therefore care has to be taken when handling the container.
19. a) Be cautions about touching parts other than control panel during or immediately following grill or combi cooking.
b) Always use hot pads or oven mitts when placing or removing food and/or accessories from the oven.

SAVE THESE INSTRUCTIONS

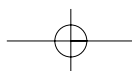

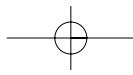

FEATURES DIAGRAM

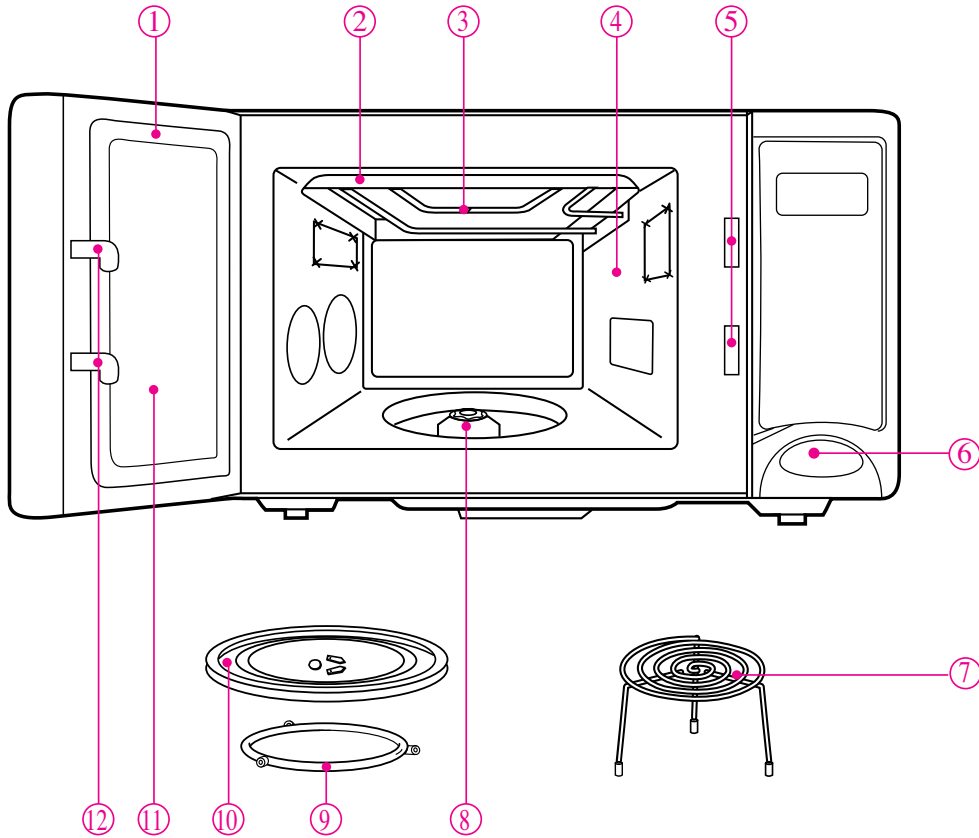

- ① **Door seal** - Door seal maintains the microwave energy within the oven cavity and prevents microwave leakage.
- ② **Reflector (Insulator Heater)**
- ③ **Heating Element**
- ④ **Oven cavity**
- ⑤ **Safety interlock system**
- ⑥ **Door release button** - By pushing this button the latch system cut off all circuits and stops the oven before the door is opened.
- ⑦ **Metal Rack**
- ⑧ **Coupler** - This fits over the shaft in the center of the ovens cavity floor. This is to remain in the oven for all cooking.
- ⑨ **Roller guide** - This must always be used for cooking together with the glass cooking tray.
- ⑩ **Glass cooking tray** - Made of special heat resistant glass. Food in a proper receptacle is placed on this tray for cooking.
- ⑪ **Door viewing screen** - Allows viewing of food. The screen is designed so that light can pass through, but not the microwave.
- ⑫ **Door hook** - When the door is closed, it will automatically shut off. If the door is opened while the oven is operating, the magnetron will immediately stop operating.

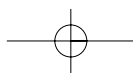

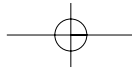

FEATURES DIAGRAM (continued)

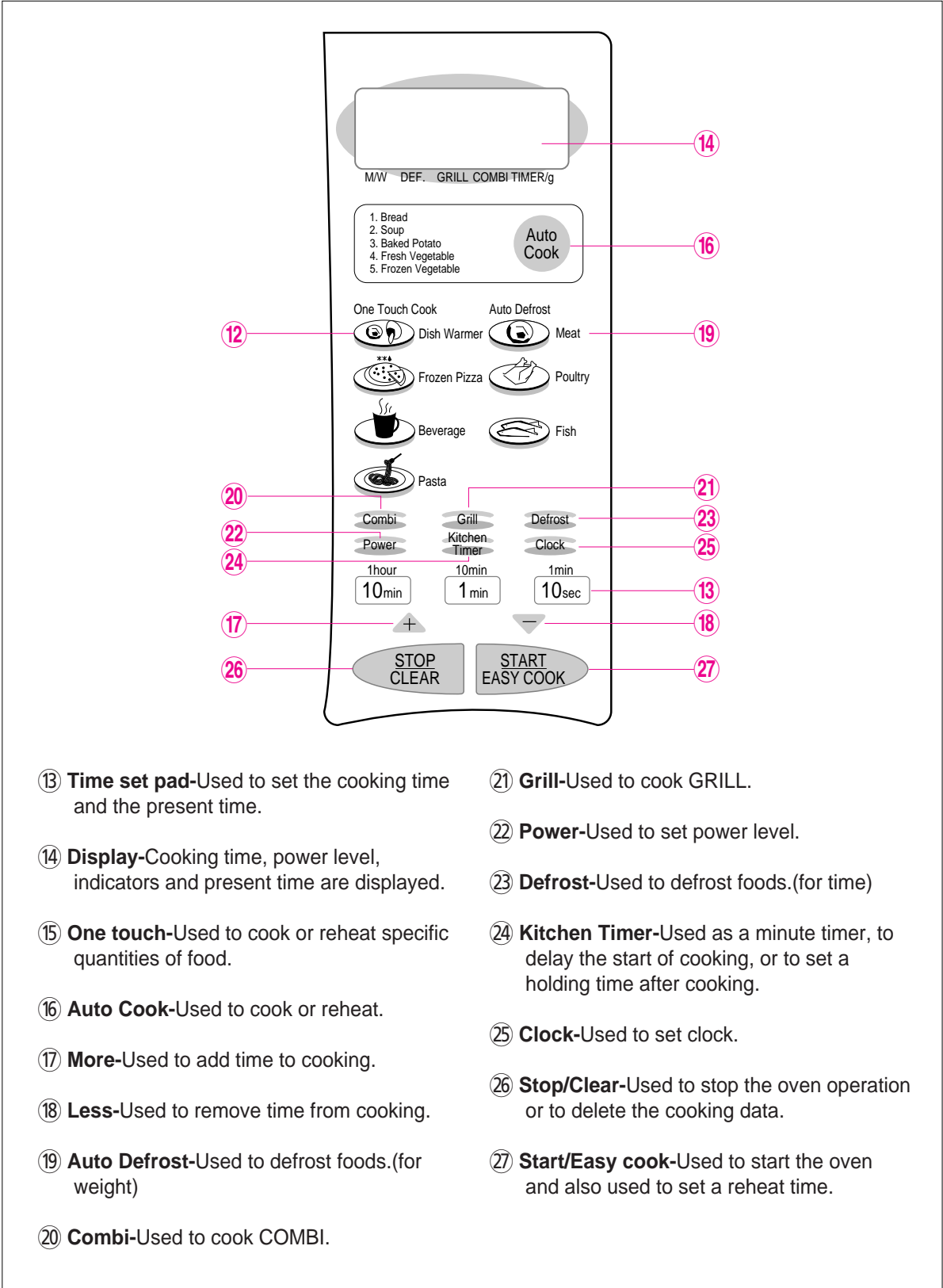

- ⑬ **Time set pad**-Used to set the cooking time and the present time.
- ⑭ **Display**-Cooking time, power level, indicators and present time are displayed.
- ⑮ **One touch**-Used to cook or reheat specific quantities of food.
- ⑯ **Auto Cook**-Used to cook or reheat.
- ⑰ **More**-Used to add time to cooking.
- ⑱ **Less**-Used to remove time from cooking.
- ⑲ **Auto Defrost**-Used to defrost foods.(for weight)
- ⑳ **Combi**-Used to cook COMBI.
- ㉑ **Grill**-Used to cook GRILL.
- ㉒ **Power**-Used to set power level.
- ㉓ **Defrost**-Used to defrost foods.(for time)
- ㉔ **Kitchen Timer**-Used as a minute timer, to delay the start of cooking, or to set a holding time after cooking.
- ㉕ **Clock**-Used to set clock.
- ㉖ **Stop/Clear**-Used to stop the oven operation or to delete the cooking data.
- ㉗ **Start/Easy cook**-Used to start the oven and also used to set a reheat time.

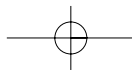

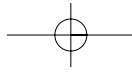

OPERATION PROCEDURE

This section includes useful information about oven operation.

- a. Plug power supply cord into a 230V 50Hz power outlet.
- b. After placing the food in a suitable container, open the oven door and put it on the glass tray.
The glass tray and roller guide must always be in place during cooking.
- c. Shut the door. Make sure that it is firmly closed.

- 1 The oven light is on only when the microwave oven is operating.
- 2 The oven door can be opened at any time during operation by touching the door release button on the control panel. The oven will automatically shut off.
- 3 Each time a pad is touched, a BEEP will sound to acknowledge the touch.
- 4 The oven automatically cooks on full power unless set to a lower power level.
- 5 The display will show “ : 0” when the oven is plugged in.
- 6 Time clock returns to the present time when the cooking time ends.
- 7 When the STOP/CLEAR pad is touched during the oven operation, the oven stops cooking and all information retained. To erase all information(except the present time), touch the STOP/CLEAR pad once more.
If the oven door is opened during the oven operation, all information is retained.
- 8 If the START pad is touched and the oven does not operate, check the area between the door and door seal for obstructions and make sure the door is closed securely. The oven will not start cooking until the door is completely closed or the program has been reset.
- 9 NOTE : When using the GRILL or COMBI mode;
 - Do not open the door so often, the temperature inside the oven decrease and the cooking may not be completed in setting time.
 - Never touch the oven window and metal interior of the oven when taking food in and out, because the temperature inside the oven and door is very high.
 - When using these modes, be careful as the tray will be hot to touch, use oven gloves or pot holders while handling tray.

Make sure the oven is properly installed and plugged into the electrical outlet.

WATTAGE OUTPUT CHART

- The power-level is set by pressing the Power pad. The chart shows the display, the power level and the percentage of power.

Touch Power pad	Power level (Display)	Approximate Percentage of Power
once	P-HI	100%
twice	P-90	90%
3 times	P-80	80%
4 times	P-70	70%
5 times	P-60	60%
6 times	P-50	50%
7 times	P-40	40%
8 times	P-30	30%
9 times	P-20	20%
10 times	P-10	10%
11 times	P-00	0%

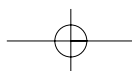

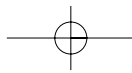

CONTROLS

SETTING THE CLOCK

When the oven is first plugged in, the display will flash “:0” and a tone will sound. If the AC power ever goes off, the display shows “:0” when the power comes back on.

Clock

1. Touch Clock pad.
This is a 12 hour clock system.
2. Touch Clock pad once more.
This is a 24 hour clock system.

NOTE : This oven has multiple clock systems. If you want 12 hour clock system, omit this step.

3. Enter the correct time of day by touching the time set pads.

4. Touch Clock pad.

Clock

The display stops blinking, and the colon starts blinking. If you selected 12 hour clock system, this digital clock allows you to set from 1:00 to 12:59. If you selected 24 hour clock system, this digital clock allows you to set from 0:00 to 23:59.

NOTE: If you attempt to enter an incorrect time, the time will not be set and a error signal tone will sound. Touch the Clock pad and re-enter the time.

TIME DEFROSTING

When Defrost is selected, the automatic cycle divides the defrosting time into periods of alternating defrost and stand times by cycling on and off.

Defrost

1. Touch Defrost pad.
2. Touch the time set pads for the desired time.

The Def. indicator lights and “:0” is displayed.

The display will show what you touched.

Note : Your oven can be programmed for 59 minutes 90 seconds. (59 : 90)

3. Touch START pad.

When you touch START pad, the Def. indicator starts blinking to show the oven is in the DEFROST mode. The display counts down the time to show you how much defrosting time is left in the DEFROST mode. The oven beeps during the defrosting cycle to signal that the food needs to be turned or rearranged. When the defrosting time ends, you will hear 3 beeps.

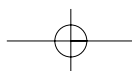

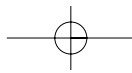

WEIGHT DEFROSTING

Auto Defrost lets you easily defrost food by eliminating guesswork in determining defrosting time. Follow the steps below for easy defrosting.

- | | | |
|-------------|--|---|
| Meat | 1. Touch Meat pad. | The Timer/g indicator light and “ 500 ” is displayed. |
| | 2. Select the desired defrosting weight.
(Refer to the weight defrost chart below.) | The display will show what you touched. |
| | 3. Touch START pad. | MEAT DEFROSTING begins. |

- | | | |
|----------------|--|--|
| Poultry | 1. Touch Poultry pad. | The Timer/ g indicator light and “ 800 ” is displayed. |
| | 2. Select the desired defrosting weight.
(Refer to the weight defrost chart below.) | The display will show what you touched. |
| | 3. Touch START pad. | POULTRY DEFROSTING begins. |

- | | | |
|-------------|--|---|
| Fish | 1. Touch Fish pad. | The Timer/g indicator light and “ 300 ” is displayed. |
| | 2. Select the desired defrosting weight.
(Refer to the weight defrost chart below.) | The display will show what you touched. |
| | 3. Touch START pad. | FISH DEFROSTING begins. |

* WEIGHT DEFROST CHART

Touch pad	MEAT	POULTRY	FISH
once	500g	800g	300g
twice	800g	1000g	500g
3 times	1000g	1200g	800g
4 times	1200g	1500g	1000g

The defrosting time is automatically determined by the weight selected. When you touch START pad, the Timer/g indicator goes off and the Def. indicator blinks and the defrosting time counts down in the display window. The oven beeps during the defrosting cycle to signal that the food needs to be turned or rearranged. When the defrosting time ends, you will hear 3 beeps.

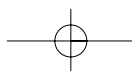

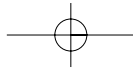

COOKING IN ONE STAGE



X 6

1. Touch Power pad.
(Select the desired power level.)

The M/W indicator lights.
The display will show what you touched.
This example shows power level 5.

Note : If steps 1 and 2 are omitted,
the oven will cook at full power.

2. Touch the time set pads for the cooking time.

The display will show what you touched.

Note : Your oven can be programmed for
59 minutes 90 seconds. (59 : 90)

3. Touch START pad.

When you touch START pad, the M/W indicator starts blinking to show the oven is cooking.
The display counts down the time to show how much cooking time is left. When the cooking time ends, you will hear 3 beeps.

NOTE: Using lower power levels increases the cooking time which is recommended for foods such as cheese, milk and slow cooking of meats.

COOKING IN TWO STAGES

All recipes require frozen foods to be defrosted fully before cooking.
This oven can be programmed to automatically defrost foods before cooking.



1. Touch Defrost pad.

The Def. indicator lights and “ : 0” is displayed.

2. Touch the time set pads for the defrosting time you want.

The display will show what you touched.



X 6

3. Touch Power pad.
(Select the desired power level.)

The M/W indicator lights and “P-HI” is displayed.
The display will show what you touched.
This example shows power level 5.

4. Touch the time set pads for the desired cooking time.

The display will show what you touched.

5. Touch START pad.

When you touch START pad, the Def. and M/W indicators come on to confirm the power levels selected. The Def. indicator starts blinking to show you that the oven is in DEFROST mode. The display counts down the time remaining in DEFROST mode. When the oven beeps, turn over, break apart and/or redistribute the food. At the end of DEFROST mode, the oven will beep and start M/W cook. The Def. indicator goes off and the M/W indicator starts blinking. The display counts down the time remaining in M/W mode. When M/W cook ends, you will hear 3 beeps.

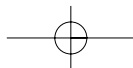

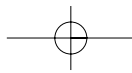

GRILL COOKING

This function allows you to brown food quickly. The heating element is located in the top of the oven. There is no pre-heating the oven for grill cooking. Place food inside the oven when setting the controls.



1. Touch GRILL pad.

The Grill indicator lights and “ : 0” is displayed.

2. Touch the time set pads for the cooking time.

The display will show what you touched.

Note : Time can be set up to 29 minutes
90 seconds.

3. Touch START pad.

When you touch START pad, the Grill indicator starts blinking to show the oven is cooking. The display counts down the time to show how much cooking time is left. When the cooking time ends, you will hear 3 beeps.

COMBI COOKING

The oven has combination mode which cooks food with heater and microwave at the same time. The combination mode accelerates the cooking process.



1. Touch COMBI pad.

The Combi indicator lights and “ : 0” is displayed.

2. Touch the time set pads for the cooking time.

The display will show what you touched.

Note : Time can be set up to 59 minutes
90 seconds.

3. Touch START pad.

When you touch START pad, the Combi indicator starts blinking to show the oven is cooking. The display counts down the time to show how much cooking time is left. When the cooking time ends, you will hear 3 beeps.

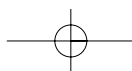

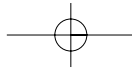

KITCHEN TIMER MODE

Timer operates as a minute timer, can be set to delay cooking and used to set a holding time after cooking. However delay cooking can not be programmed for defrost. Timer operates without microwave energy.

HOW TO USE AS A MINUTE TIMER

- | | | |
|---|--|---|
| <div style="border: 1px solid black; padding: 5px; width: fit-content;">Kitchen
Timer</div> | <p>1. Touch Kitchen Timer pad.</p> | <p>The Timer/g indicator lights and “ : 0 ” is displayed.</p> |
| | <p>2. Press the amount of time you want to count down.</p> | <p>The display will show what you touched.</p> |
| | <p>3. Touch START pad.</p> | |

The Timer/g indicator starts blinking and the display counts down the time remaining in KITCHEN TIMER mode. When KITCHEN TIMER mode ends, you will hear 3 beeps.

HOW TO USE TO DELAY THE START OF COOKING

- | | | |
|---|---|--|
| <div style="border: 1px solid black; padding: 5px; width: fit-content;">Kitchen
Timer</div> | <p>1. Touch Kitchen Timer pad.</p> | <p>The Timer/g indicator lights and “ : 0 ” is displayed.</p> |
| | <p>2. Press the amount of time you want to delay.</p> | <p>The display will show what you touched.</p> |
| | <p>3. Program the desired power level and cooking time for food to be cooked.</p> | <p>The M/W indicator lights and the selected power level & cooking time are displayed.</p> |
| | <p>4. Touch START pad.</p> | |

When you touch START pad, the Timer/g indicator starts blinking and the display counts down the time remaining in KITCHEN TIMER mode. When KITCHEN TIMER mode ends, the oven will beep. The Timer/g indicator goes off and M/W indicator starts blinking. The display counts down the time remaining in M/W mode. When M/W cook ends, you will hear 3 beeps.

HOW TO USE TO SET A HOLDING TIME

- | | | |
|---|---|---|
| <div style="border: 1px solid black; padding: 5px; width: fit-content;">Kitchen
Timer</div> | <p>1. Program the desired cooking time.</p> | <p>The M/W indicator lights and the selected time is displayed.</p> |
| | <p>2. Touch Kitchen Timer pad.</p> | <p>The Timer/g indicator lights and “ : 0 ” is displayed.</p> |
| | <p>3. Press the amount of time you want the oven to hold.</p> | <p>The display will show what you touched.</p> |
| | <p>4. Touch START pad.</p> | |

The M/W indicator starts blinking and the display counts down the time remaining in M/W mode. When the M/W cook ends, the oven will beep. The M/W indicator goes off and Timer/g indicator starts blinking. The display counts down the time remaining in KITCHEN TIMER mode. When the KITCHEN TIMER mode ends, you will hear 3 beeps.

Note : Your oven can be programmed for 59 minutes 90 seconds. (59 : 90)

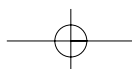

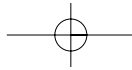

EASY COOK

EASY COOK allows you to reheat for 30 seconds at 100% (full power) by simply touching the EASY COOK pad.

By repeatedly touching the EASY COOK pad, you can also extend reheating time to 5 minutes by 30 second increments.

EASY COOK	1. Touch EASY COOK pad.	When you touch EASY COOK, ":30" is displayed. After 1.5 seconds, the oven starts reheating.
----------------------	-------------------------	--

ONE TOUCH COOKING

One touch cook allows you to cook or reheat many of your favorite foods by touching just one pad. To increase quantity, touch chosen pad until number in display is same as desired quantity to cook.

Pasta	1. Touch Pasta pad once for 1 serving or twice for 2 serving.	When you touch Pasta pad once, " 1" is displayed. After 1.5 seconds, the display is changed into cooking time and the oven starts cooking.
--------------	---	---

*PASTA *

- 1 serving : Touch Pasta once.
- 2 serving : Touch Pasta twice within 1.5 seconds.

- NOTE:**
1. Place pasta into a deep casserole and double quantity of water.
 2. Cover with lid or plastic wrap. After cooking, stir.
 3. If possible, let stand 3 to 5 minutes or until liquid has been absorbed.

Frozen Pizza	1. Touch Frozen Pizza pad once for 200g pizza or twice 400g pizza.	When you touch Frozen Pizza pad once, " 200 " is displayed. After 1.5 seconds, the display is changed into the cooking time and the oven starts cooking.
-------------------------	--	---

* FROZEN PIZZA *

- 200 g : Touch Frozen Pizza once.
- 400 g : Touch Frozen Pizza twice within 1.5 seconds.

- NOTE:**
- 1 Use only one frozen pizza at a time
 2. Use only frozen pizza made for microwave ovens.
 3. If the cheese of frozen pizza does not melt sufficiently, cook a few seconds longer.
 4. Some brands of frozen pizza may require more or less cooking time.

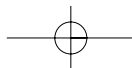

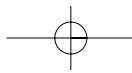

ONE TOUCH COOKING (continued)

Beverage	1. Touch Beverage pad once for 1 cup, twice for 2 cups or three times for 3 cups.	When you touch Beverage pad once, "1" is displayed. After 1.5 seconds, the display is changed into cooking time and the oven starts cooking.
-----------------	---	---

* BEVERAGE(200ml/cup) *

- 1 cup (mug): Touch Beverage once.
- 2 cups (mugs): Touch Beverage twice within 1.5 seconds.
- 3 cups (mugs): Touch Beverage three times within 1.5 seconds.

Dish Warmer	1. Touch Dish Warmer pad once for 350g or twice for 450g.	When you touch Dish Warmer pad once, "350" is displayed. After 1.5 seconds, the display is changed into cooking time and the oven starts cooking.
--------------------	---	--

* DISH WARMER *

- 350 g: Touch Dish Warmer once.
- 450 g: Touch Dish Warmer twice within 1.5 seconds.

- NOTE:** 1. Put food on microwave plate.
2. Cover with vented plastic wrap.

AUTO COOK

Auto Cook allows you to cook or reheat many of your favorite foods by repeatedly touching auto cook pad.

Auto Cook	1. Touch Auto Cook pad.	When you touch Auto Cook pad once, "AC-1" is displayed. By repeatedly touching this pad, you can select other food category as shown in the chart below.
------------------	-------------------------	--

CATEGORY	FOOD	WEIGHT	TOUCH PAD
AC-1	BREAD	4 slices(40-50g each)	Touch Auto Cook once
AC-2	SOUP	350g	Touch Auto Cook twice
AC-3	BAKED POTATO	3 potatoes(200~250g each)	Touch Auto Cook three times
AC-4	FRESH VEGETABLE	200g	Touch Auto Cook four times
AC-5	FROZEN VEGETABLE	200g package	Touch Auto Cook five times

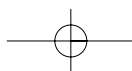

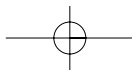
START

2. Touch START pad.

When you touch START pad, the display is changed into cooking time and the oven starts cooking.

LESS, MORE

To alter one touch cooking or cooking time whilst oven is in operation, use LESS or MORE.(except for defrosting)

Press LESS/MORE to decrease/increase the one touch cooking time in multiples of 10 seconds.

The overall one touch cooking time can be increased to a maximum of 59 minutes 50 seconds.

Press LESS/MORE to decrease/increase the cooking time in multiples of 1 minute.

The overall cooking time can be increased to a maximum of 59 minutes.

CHILD SAFETY LOCK

The safety lock prevents unwanted oven operation such as by small children.

To set, press and hold STOP/CLEAR for 3 seconds, and a beep sounds. Each time a pad(except STOP/CLEAR) is touched, "LOC" is displayed.

To cancel, press and hold STOP/CLEAR for 3 seconds, and a beep sounds.

TO STOP THE OVEN WHILE THE OVEN IS OPERATING

1. Press STOP/CLEAR pad.

- You can restart the oven by touching START pad.
- Touch STOP/CLEAR once more to erase all instructions.
- You must enter in new instructions.

2. Open the door.

- You can restart the oven by closing the door and touching START.

NOTE: Oven stops operating when door is opened.

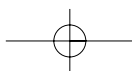

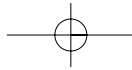

COOKING UTENSILS

Utensils should be checked to ensure that they are suitable for use in microwave ovens. Microwave energy is produced by high frequency radio waves. They are reflected from metal, but will pass through most cooking utensils without heating them.

As the waves come into contact with the food, they are converted into heat energy. Listed below are the suggested cooking utensils for this microwave oven and when to use them.

Before use, the user should check that utensils are suitable for use in microwave ovens.

Material	Grill cooking	Microwave cooking	Combined cooking
Glass (general)	No	Yes(1)	No
Glass (heat resistant)	Yes	Yes	Yes
Glass-ceramic and ceramic (heat resistant)	Yes	Yes(1)	Yes(1)
Earthenware	Yes	Yes	Yes
China (heat resistant)	Yes	Yes	Yes
Plastic (general)	No	Yes(2)	No
Plastic (heat resistant)	Yes(2)	Yes(2)	Yes(2)
Aluminum foil containers/ Aluminum foil	Yes	Yes(3)	Yes
Metal baking tins	Yes(4)	No	Yes(4)
Metal (pots, pans, etc.)	Yes	No	No
Paper	No	Yes	No

1. Without metal parts or metal trims.
2. Some plastics are heat-proof only to certain temperature. Check carefully!
3. It is possible to use aluminum foil to shield delicate areas of food.(This prevents over-cooking.)
4. Metal tins can be used in the combination methods, however if these are very deep, they will greatly reduce the efficiency, as metal shields the microwave energy from the food.

CARE AND CLEANING

Although your oven is provided with safety features, it is important to observe the following:

1. It is important not to defeat or tamper with safety interlocks.
2. Do not place any object between the oven front face and the door or allow residue to accumulate on sealing surfaces. Wipe the sealing area frequently with a mild detergent, rinse and dry. Never use abrasive powders or pads.
3. When opened, the door must not be subjected to strain, for example, a child hanging on an opened door or any load could cause the oven to fall forward to cause injury and also damage to the door. Do not operate the oven if it is damaged, until it has been repaired by a trained service technician.

It is particularly important that the oven closes properly and that there is no damage to the:

- i) Door(bent)
 - ii) Hinges and Hookes(broken or loosened)
 - iii) Door seals and sealing surfaces.
4. The oven should not be adjusted or repaired by anyone except a properly trained service technician.

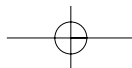

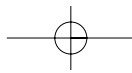

BEFORE YOU CALL FOR SERVICE

Refer to following checklist, you may prevent an unnecessary service call.

* The oven doesn't work :

1. Check that the power cord is securely plugged in.
2. Check that the door is firmly closed.
3. Check that the cooking time is set.
4. Check for a blown circuit fuse or tripped main circuit breaker in your house.

* Sparking in the cavity;

1. Check utensils. Metal containers or dishes with metal trim should not be used.
2. Check that metal skewers or foil does not touch the interior walls.

If there is still a problem, contact the service station.

A list of these stations is included in the oven.

DO NOT ATTEMPT TO SERVICE THE OVEN YOURSELF !

QUESTIONS AND ANSWERS

* Q: I accidentally ran my microwave oven without any food in it. Is it damaged?

A: Running the oven empty for a short time will not damage the oven. However, it is not recommended.

* Q: Can the oven be used with the glass tray or roller guide removed?

A: No. Both the glass tray and roller guide must always be used in the oven before cooking.

* Q: Can I open the door when the oven is operating?

A: The door can be opened anytime during the cooking operation. Then microwave energy will be instantly switched off and the time setting will maintain until the door is closed.

* Q: Why do I have moisture in my microwave oven after cooking?

A: The moisture on the side of your microwave oven is normal. It is caused by steam from cooking food hitting the cool oven surface.

* Q: Does microwave energy pass through the viewing screen in the door?

A: No. The metal screen bounces back the energy to the oven cavity. The holes are made to allow light to pass through. They do not let microwave energy pass through.

